

KEY FUNCTIONS

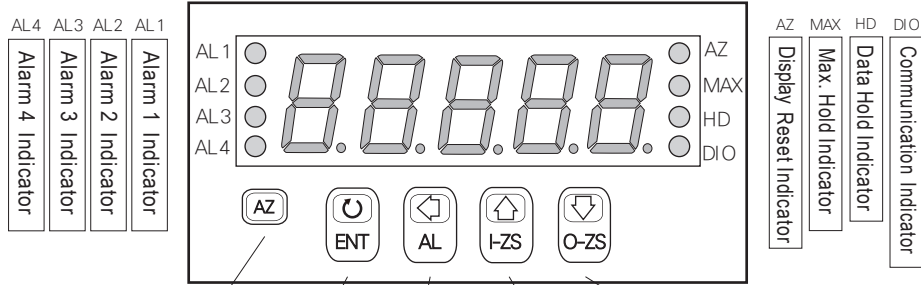

Function Key Enter Key & Save Key Shift Key & Alarm Setting Key Up Key & Display Setting Key Down Key & A/O Setting Key

Measuring Status	Enable the setting function	Hold for 3 sec. enter to Alarm Setpoint Modification	Hold for 3 sec. enter to Display Group Setting	Hold for 3 sec. enter to A/O Group Setting.	<p>In any status can back to measuring status</p>
Parameter Page	Enter to parameter groups	Enter to parameter setting	Back to the last parameter page	Go to the next parameter page	
Parameter Setting	Save the value	Move the cursor left	Increase the digit	Decrease the digit	

WIRING CONNECTION

Input Function

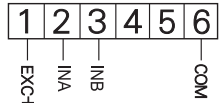

Power

- AC Power



- DC Power



Output Function

- A/O output



- RS-485 output



Relay Function

- Relay x1~3

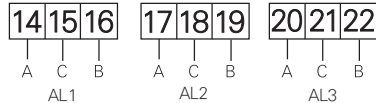

- Relay x4

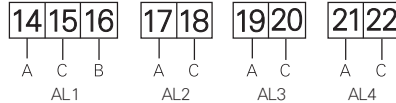

External Control Function

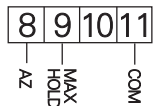

Programming Mode Operating Procedures

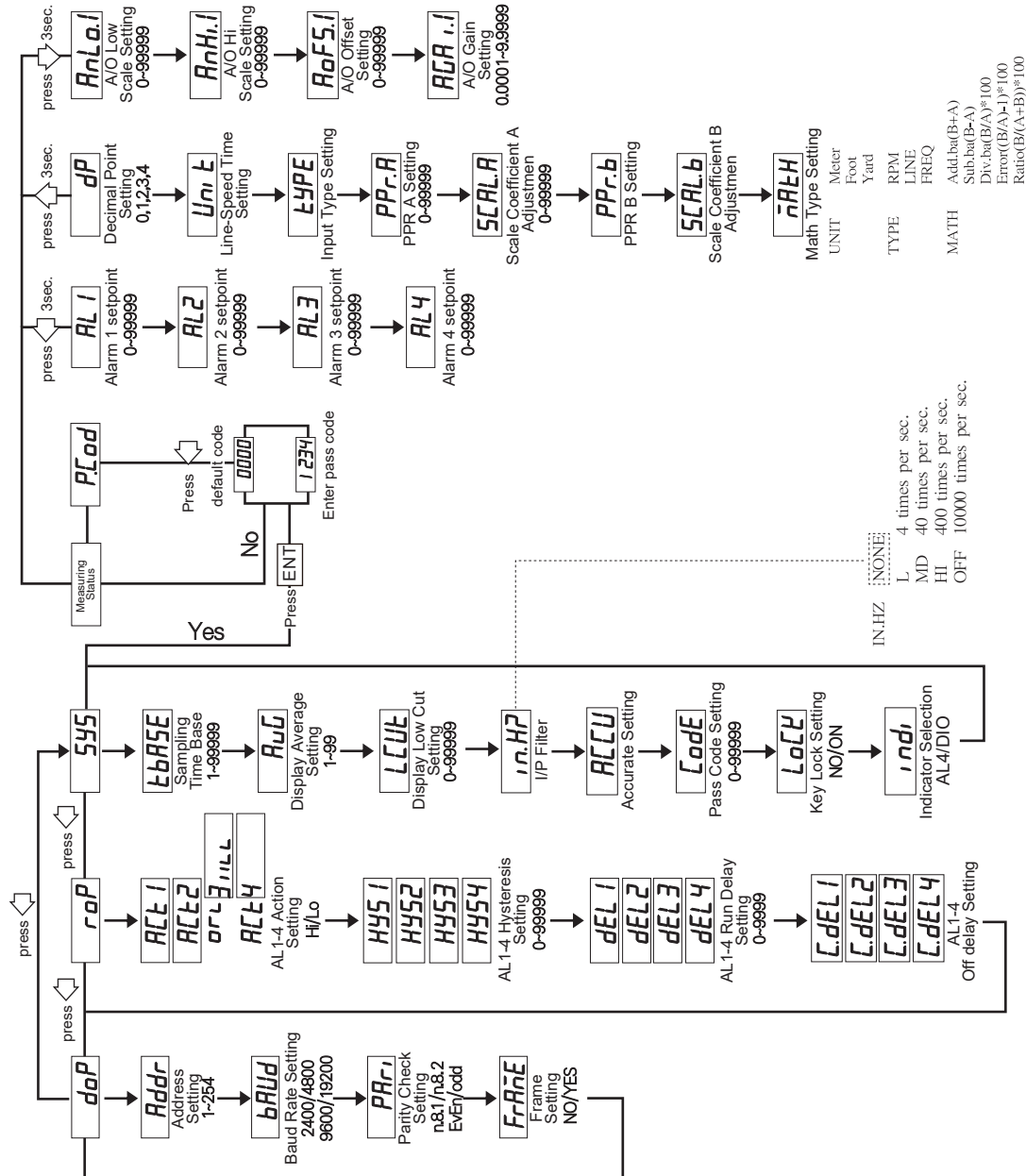

IN.HZ: NONE, L (4 times per sec.), MD (40 times per sec.), HI (400 times per sec.), OFF (10000 times per sec.)

MATH: Add.(B+A), Sub.(B-A), Div.(B/A)*100, Error((B/A)-1)*100, Ratio(B/(A+B))*100

Input Signal Modification

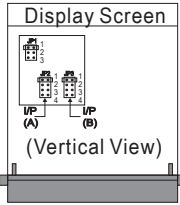

**To Select the pin to modify the input signal for different sensors.
PS: In dual input type, excitation power must be the same.

JP1	JUMPER	DEFINITION
	1	Close: 24V
	2	Close: 12V
	3	Close: 5V

JP2/JP3	JUMPER	DEFINITION
	1	Open: 100KHz Close: 10KHz
	2	Close: 1KHz
	3	Open: NPN; Close: PNP
	4	Open: PNP; Close: NPN

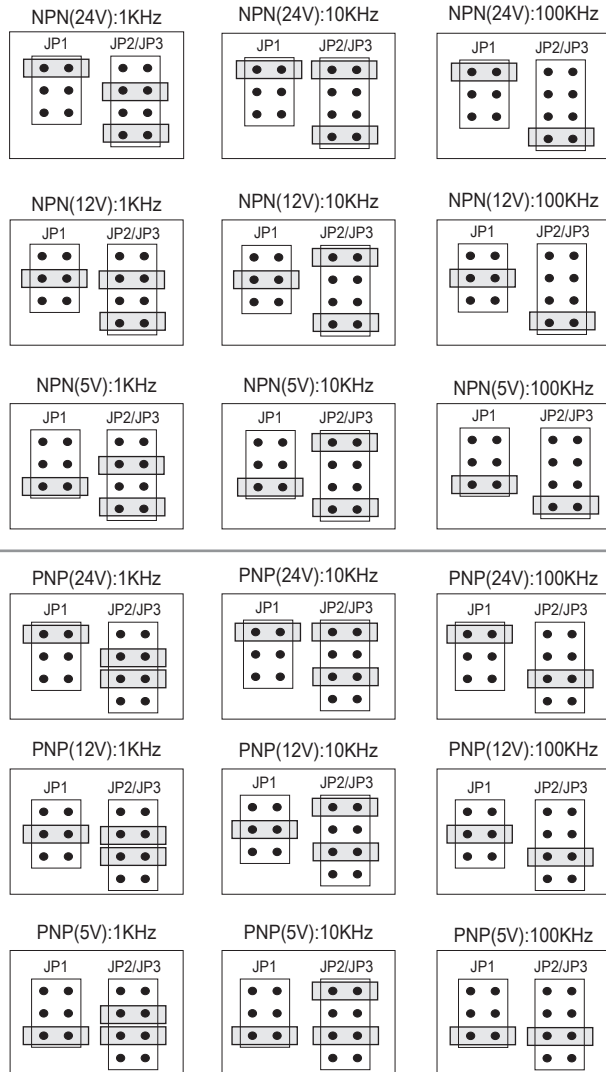

Modbus RTU Mode Protocol Address Table

Data: 16Bit / 32Bit, +/- is 8000~7FFF (-32768~32767), 80000000~7FFFFFFF (-2147483648~2147483647)

Modbus	HEX	Name	Descriptions	Act
40001	0000	ID	Model number identification; MA5H-R is "01"	R
40002	0001			
40003	0002			
40004	0003	DP	Decimal point setting; range: 0000~0003 (0~3) 0:10 ⁰ , 1:10 ¹ , 2:10 ² , 3:10 ³	R/W
40005	0004	BAUD	Baud rate setting; range: 0000~0003 (0~3) 0:19200, 1:9600, 2:4800, 3:2400	R/W
40006	0005	PARI	Parity setting; range: 0000~0003 (0~3), 0:N.8.2., 1:N.8.1., 2:EVEN, 3:ODD	R/W
40007	0006	AVG	Display average setting; range: 0001~0063 (1~99)	R/W
40008	0007	LCUT	Display low cut setting; range: 0000~0063 (0~99)	R/W
40009	0008	ADDR	Address setting; range: 0000~00FF (0~255)	R/W
40019	0012	CODE	Pass code setting; range: 00000000~0001869F (0~99999) Hi Bit	R/W
40020	0013		Pass code setting; range: 00000000~0001869F (0~99999) Low Bit	R/W
40038	0025	pV	Range: FFFCF2C1~000F423F (-19999~99999)	R
40039	0026		Range: FFFCF2C1~000F423F (-19999~99999)	R
40045	002C	DISPLAY	Range: FFFFB1E1~0001869F (-19999~99999)	R
40046	002D		Range: FFFFB1E1~0001869F (-19999~99999)	R
				R
				R

ERROR CODE OF SELF-DIAGNOSIS

E-00 EEPROM reading / writing suffers the interference (about 1 million times).